

INTRODUCTION	3
GENERAL OVERVIEW	3
SAFETY AND PRECAUTIONS.....	3
<i>Safety precautions and switch-on</i>	3
<i>Electrostatic precaution (ESP)</i>	3
INITIAL INSTALLATION PROCEDURES	4
INSTALLING THE CCU	7
LOCATION FOR CENTRAL CONTROL UNIT (CCU).....	7
MOUNTING THE CCU.....	7
<i>CCU Mounting bracket</i>	8
SECURING THE CCU TO THE WALL	10
BASE MOTHER BOARD.....	11
SYSTEM MODULES AND EXPANSION CARDS.....	12
EXTENSION EXPANSION CARD	13
<i>Extension expansion board column support</i>	14
<i>Allowed extension expansion card locations</i>	14
PSTN EXPANSION CARD	15
<i>Allowed PSTN Expansion card locations</i>	16
ISDN CLOCKING CARD.....	17
<i>ISDN clocking card (upgrade module) location</i>	18
ISDN2 CARD (BRI)	19
<i>Allowed locations of ISDN expansion card</i>	20
SYSTEM ISDN SETTINGS	21
<i>Terminating resistors</i>	21
BASE MOTHERBOARD CONNECTIONS	21
EXPANSION BOARD CONNECTIONS.....	22
VOICE MAIL.....	24
V24/SMDR SERIAL PORT.....	25
<i>External serial port cable and connectors</i>	26
<i>External serial port Pin-out</i>	27
DOOR INTERCOM.....	28
REPLACEMENT OF SYSTEM PRINTED CIRCUIT BOARD (PCB) MODULES	29
POWER SUPPLY.....	29
<i>Replacing a power supply unit</i>	30
CAUTION	30
INSTALLING THE BATTERY BACK-UP.....	31
<i>Mounting the Battery Backup unit</i>	33
EXTENSION PORT (22).....	34
CENTRAL BELL.....	34
DOORSTRIKE.....	34
GENERAL CABLING AND WIRING INFORMATION.....	35
MDF WIRING TECHNIQUE	36
SYSTEMPHONE	38
FEATURE PHONE CONNECTIONS.....	38
PLACING THE SYSTEMPHONE ON A DESK TOP.....	39
WALL MOUNTING A SYSTEMPHONE	40
POWER FAIL	40
PSTN.....	40

CONNECTING TO THE NETWORK	41
ANALOGUE/PSTN LINES.....	41
206 LINE TERMINATION.....	41
412 LINE TERMINATION.....	42
ISDN LINES.....	43
<i>S-Bus terminating socket</i>	44
<i>1 T0& Optional S0 fitted</i>	44
INSTALLATION COMPLETION & POWER UP.....	44
REFITTING THE CCU COVER	45
COMMISSIONING.....	46
RECOMMENDATIONS FOR CUSTOMER TRAINING	47
TROUBLESHOOTING	47
TECHNICAL SPECIFICATION	48
CONFIGURATION TABLE	50
POWER & ENVIRONMENTAL REQUIREMENTS.....	51

Introduction

This document describes the practices to be adopted by field engineers during installation and maintenance of BT Pathway. A more detailed description of the product, along with customer programmable facilities and features, may be found in the Owner's Manual, which should be read in conjunction with this document.

General overview

- The BT Pathway is a hybrid PABX / key system, which may be equipped with a Systemphone, or approved 2-wire apparatus.
- The BT Pathway is modular in construction and can be upgraded by adding various system expansion modules
- The BT Pathway allows connection to ISDN 2 and analogue MF or LD exchange lines.
- The BT Pathway may be configured with one or two internal S-Bus interfaces for connection to approved ISDN apparatus.
- The BT Pathway is a versatile easy to use system which is easy to install and maintain

Safety and Precautions

Safety precautions and switch-on

After installing the CCU and all cabling, ensure that the following points are checked before switching the mains power on:

- The mains socket outlet shall be installed near the equipment and shall be easily accessible.
- There is a reliable earth at the mains supply socket, earth pin.
- The cabled extensions have a telephone or Systemphone connected.
- The CCU PCB cover has been replaced, if it was previously removed.
- Switch on the mains power and allow at least eight seconds for the CCU to go through its power up routine.

Electrostatic precaution (ESP)

The BT Pathway contains electrostatic sensitive components. To ensure long term reliability of the system, electrostatic precautions should be taken when handling any of the system module-PCBs.

A connector is provided on the MDF for connection of ESP straps.

If a functional earth is connected to the system it can be used for electrostatic precautions (ESP).

CAUTION

The mains protective earth should not be used for electrostatic precautions (ESP)

Initial installation procedures

Basic equipment required

Item	Quantity	BT Item code	Supplier Item code	Description
BT Pathway 2+6 CCU	1	9008	23109	Analogue system with 2 analogue lines and 6 extensions
BT Pathway 1xISDN +6 CCU	1	9025	23126	ISDN system with 1 ISDN2 line and 6 extensions
BT Pathway 4+12 CCU	1	9009	23110	Analogue system with 4 analogue lines and 12 extensions

Individual Item Description	Max. No per system	BT Item code	Supplier Item code	Description
BT Pathway Hands Free Systemphone	18	9010	23111	Fully Handsfree Systemphone which may be connected to every extension position
BT Pathway Monitor Systemphone	18	9011	23113	Monitor only Systemphone which may be connected to every extension position
2 line PSTN Expansion Card	4	9013	23116	A card which provides 2 analogue exchange lines
ISDN 2 card	5	9015	23118	A card which provides 1 ISDN 2 line interface. It can also be used to provide internal S-Bus (So) interfaces.
6 port Extension Card	2	9012	23115	The card provides 6 additional extension positions. It also provides a connector for the PSTN or ISDN expansion card.
BT Pathway Single port Voice Mail	1	9017	23120	This provides up to 80 minutes of voice storage for extension voice boxes.
BT Pathway Door Intercom	1	9020	23124	A door intercom unit which can be connected to extension position 23
V24/SMDR	1	9023	23125	This provides an interface to a printer or PC for Call logging
ISDN Upgrade kit	1	9014	23117	ISDN clocking card and 1 x ISDN2 card (see above) - connect both to an analogue system to facilitate ISDN connectivity
Battery Back up	1	9016	23118	An externally mounted unit which can house a battery to give one hours full back up in the event of a power failure
Base Motherboard	1	9245	TBA	Spare main system card containing 6 extension ports and the main system software and processor
ISDN Clocking card	1	9029	23130	Digital clocking card - required for connection to the ISDN network
PABX PSU (Spare)	1	9027	23128	Spare power supply unit
CCU Cover kit	1	9028	23129	Spare CCU cover
Handsfree systemphone x 2	9	9254	TBA	Pack of 2 Handsfree systemphones
Handsfree systemphone x 2	9	9255	TBA	Pack of 2 Monitor systemphones

Apparatus approved for connection to the BT Pathway	As required	Description
Master line jack units without GDTs	1 per extension and Central bell	
6 wire 0.5 mm cable	As required Doorstrike and Public Address (PA) systems	Doorstrike and PA Not available from BT

Installing the CCU

Location for Central Control Unit (CCU)

The CCU is intended for installation in a residential or office-type environment. It needs to be mounted at a convenient working height on a dry flat wall. The normal height is 1 metre from the floor to the bottom of the CCU case.

CAUTION

Do not site the CCU where it will be subjected to excessive levels of heat, dust damp or high humidity. Locating the equipment near sources of electromagnetic radiation such as heavy electrical switchgear, lift machinery or electric arc welders should be specifically avoided.

Allow at least 100 mm of free space all around the CCU for ventilation and 310 mm to the right or underneath the CCU for the addition of the Battery Back up unit.

The CCU needs to be within approximately two metres of a dedicated AC mains power supply outlet. The CCU must not share the same mains supply socket with any other electrical appliance.

Mounting the CCU

When a suitable location has been found, mark the screw locations on the mounting surface using the mounting bracket provided.

If the CCU is to be mounted on masonry or plaster board suitable wall plugs must be used. Drill and plug four holes in the wall at the marked locations. The holes should be deep enough to accept a 2.5cm/1 inch screw.

CCU Mounting bracket

The main unit is mounted on a wall using the bracket supplied and should have top and side clearance as shown in the following diagrams.

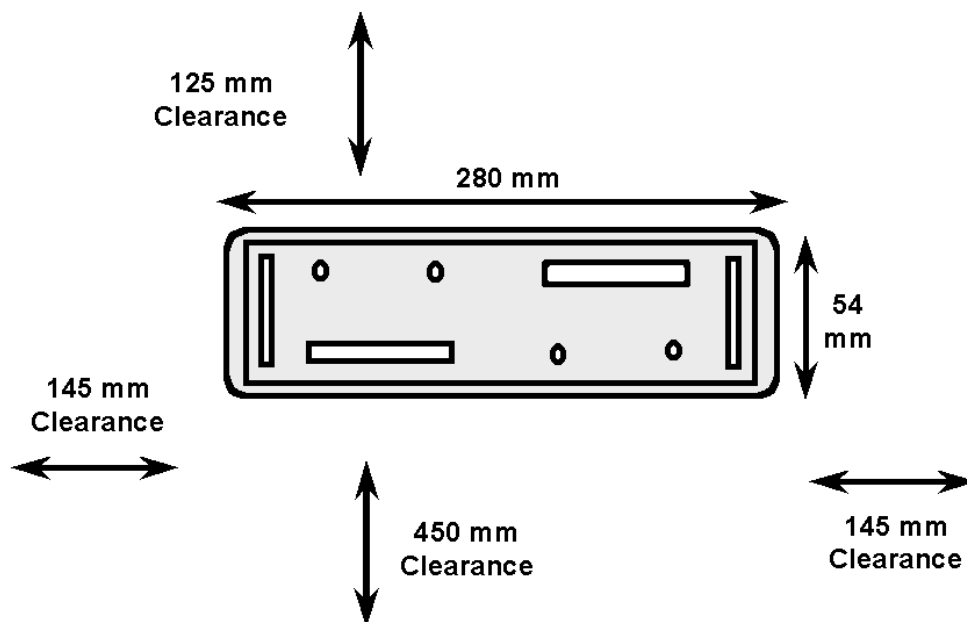

Slide the MDF cover
off by moving it upwards
by sliding it down into position

Locate the CCU
onto the wall-
mounting bracket

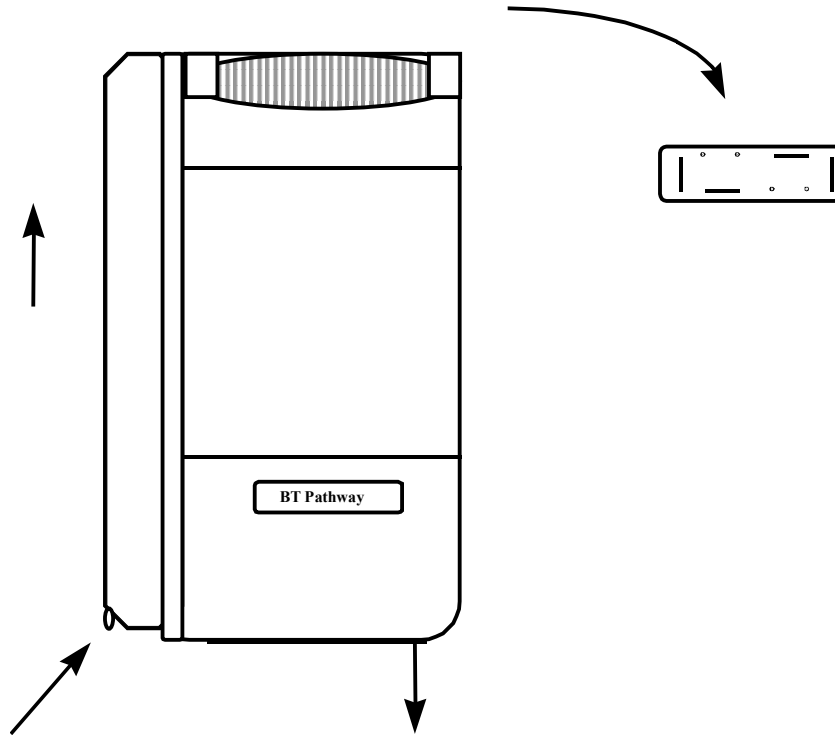

Remove the MDF cover
retaining screw.

Connect the system to the mains supply

Securing the CCU to the wall

Locate and mark the position of the Fixing screws at the top and bottom of the MDF area. Remove the unit. Drill and plug the screw holes, deep enough to accept 2.5mm/one inch No. 8 round-head screw. Relocate the unit on the bracket and screw home the fixing screws. Ensure that there is sufficient space around the CCU to allow adequate ventilation.

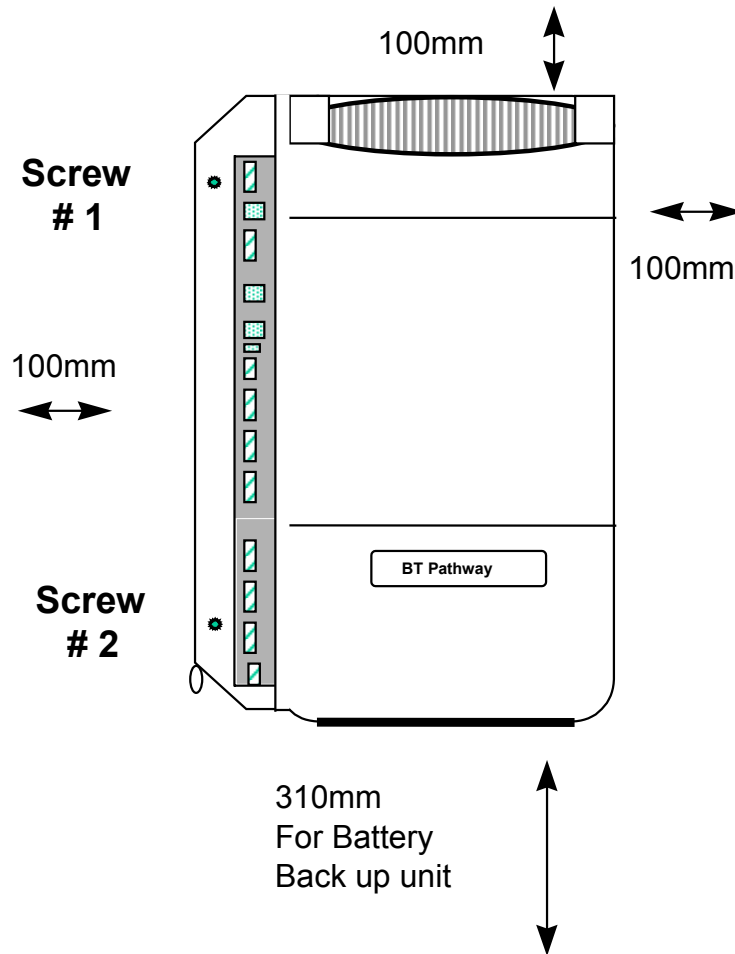

Caution

At no time should any system module be removed or inserted when power is applied to the system.
Always isolate the mains supply when installing and/or upgrading system module hardware

Note: When fitting the Battery Backup Unit (BBU), there are two similar holes to those on the main CCU, located on the left-hand side of the BBU case. These screw holes are used to secure the BBU to the wall when it has been positioned correctly on the wall-mounting bracket. Please refer to the battery back up Unit section of this document.

Base Mother Board

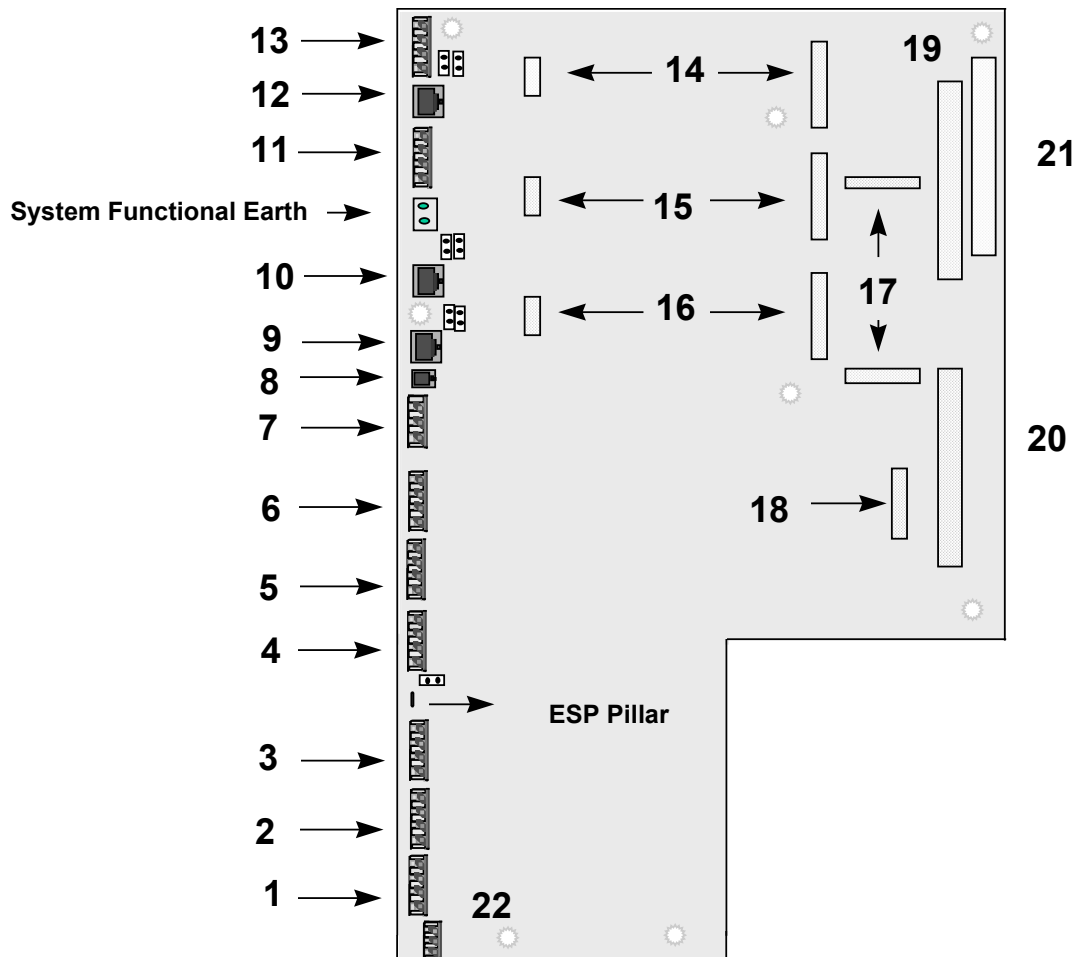

- | | |
|---|--|
| <ul style="list-style-type: none"> 1. Krone IDC connection 2. Krone IDC connection 3. Krone IDC connection 4. Krone IDC connection 5. Krone IDC connection 6. Krone IDC connection 7. Krone IDC connection 8. RJ11 connection 9. RJ45 connection 10. RJ45 connection 11. Krone IDC connection 12. RJ45 connection 13. Krone IDC connection | <ul style="list-style-type: none"> 14. Main board connector 15. Main board connector 16. Main board connector 17. Main board connector 18. Main board connector 19 & 20. Main board connector 21. Main board connection 22. Krone IDC connection |
|---|--|
-
- | |
|---|
| <ul style="list-style-type: none"> Extension 20 position Extension 21 position Extension 22 position/long line extension Extension 23 position/Door intercom Extension 24 position Extension 25 position Central Bell connection V24/SMDR - call logging interface connection Internal S-Bus connection Second To connection PSTN line 3&4 connection First To connection PSTN line 1&2 connection PSTN/ISDN expansion card connection PSTN/ISDN expansion card connection Internal So expansion card (ISDN) connection ISDN capability board connection Voice Module connection Extension expansion card connection Secondary connection (for future use) Door strike relay connection |
|---|

System Modules and expansion cards

There are a number of modules, which can be installed onto the Base Mother Board:

- Extension expansion card. This provides six extensions and a connector for a network expansion card, ISDN or analogue.
- PSTN expansion card. This card provides two analogue exchange lines.
- ISDN Expansion card. This card provides one ISDN2 interface. The same card is used for the network T₀ and the internal S bus. Links located on the card must be relocated to change the interface from T₀ to S bus operation.
- Voice module-single channel. Only one of these modules can be inserted in a unit. Both provide up to 80 minutes voice storage. When equipped each extension can be provided with a voice box. A minimum of two minutes storage is allocated automatically to each programmed extension. The remaining capacity is dynamically allocated.

Extension expansion card

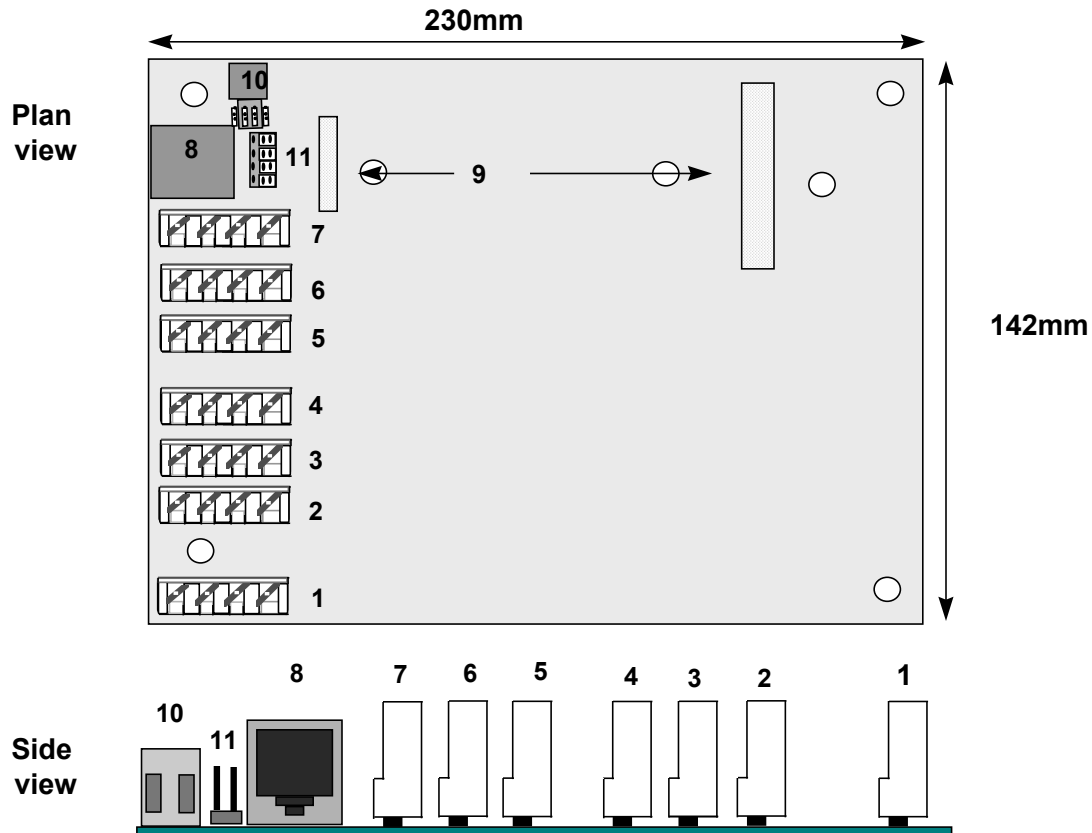

- 1. Krone IDC connection
- 2. Krone IDC connection
- 3. Krone IDC connection
- 4. Krone IDC connection
- 5. Krone IDC connection
- 6. Krone IDC connection
- 7. Krone IDC connection
- 8. RJ45 connection
- 9. Interface socket
- 10. Screw terminal connector
- 11. Jumper straps

- First Extension position
- Second Extension position
- Third Extension position
- Fourth Extension position
- Fifth Extension position
- Sixth Extension position
- PSTN line connector (Supports 2 lines)
- ISDN connector
- ISDN/PSTN expansion module position
- Functional Earth connector
- ISDN So/To option select

Extension expansion board column support

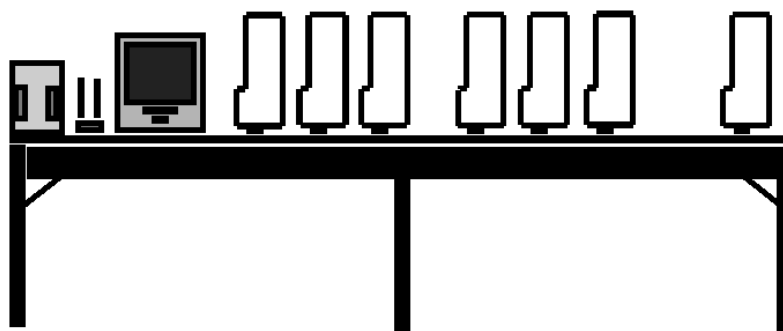

Ensure the Extension expansion card is fitted with the column support located under the line termination points.

Allowed extension expansion card locations

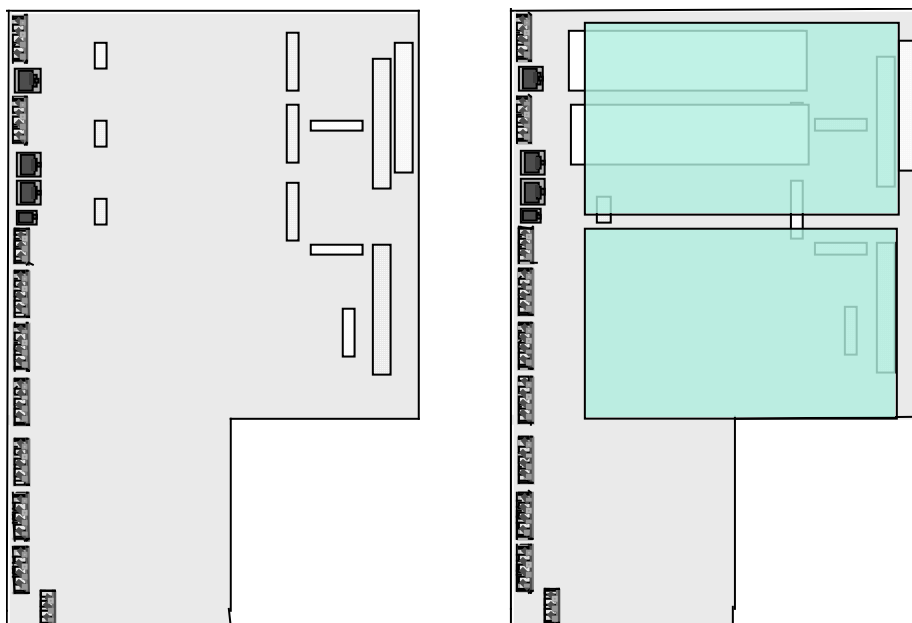

PSTN Expansion card

NOTE:

This card allows the BT Pathway to utilise two analogue trunk lines. Unless this card is fitted no analogue line access is possible when using the switch. There are no single line cards available on the BT Pathway. When only one line is in use the second line must be disabled using system programming.

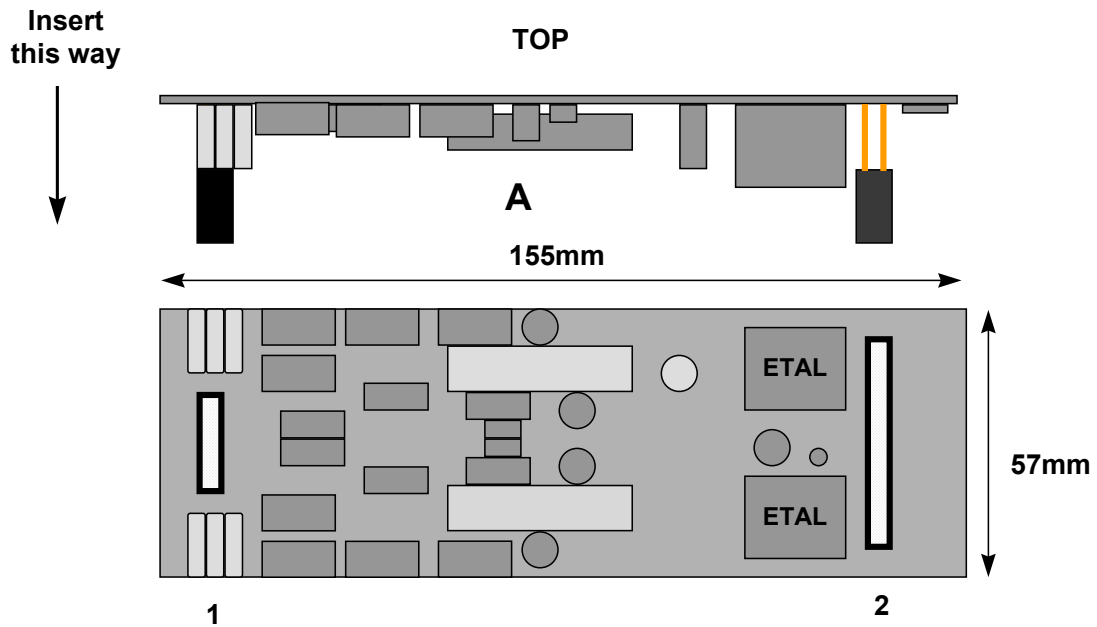

Locate PSTN expansion card into connector 14,15 or on connector 9 on extension expansion card

Allowed PSTN Expansion card locations

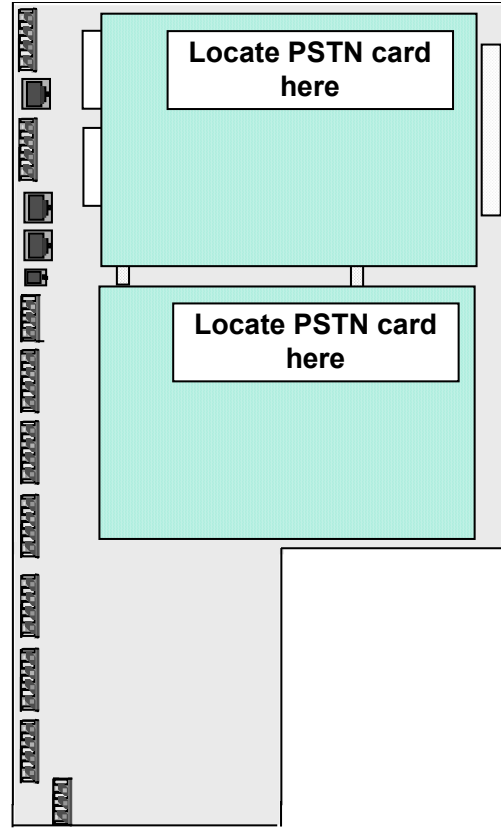
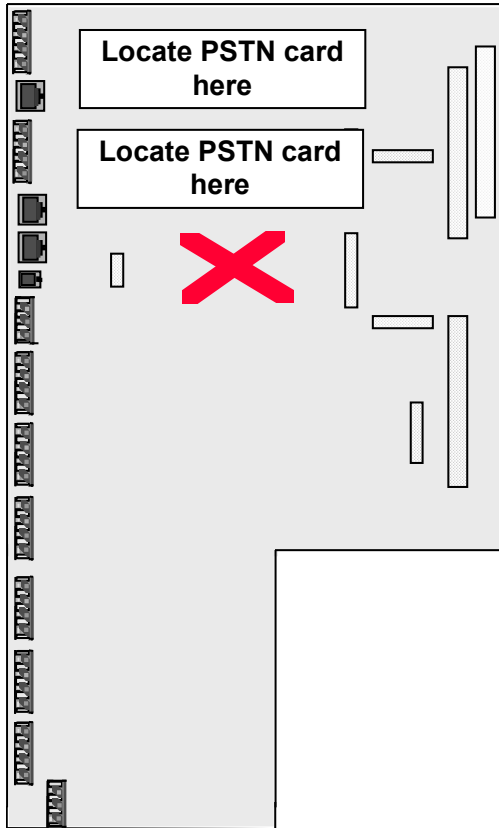

ISDN clocking card

A system, originally supplied as an analogue system, can be upgraded to an ISDN unit by installing the ISDN upgrade kit. This consists of an ISDN clocking card and ISDN2 card which interfaces to the Basic Rate ISDN line.

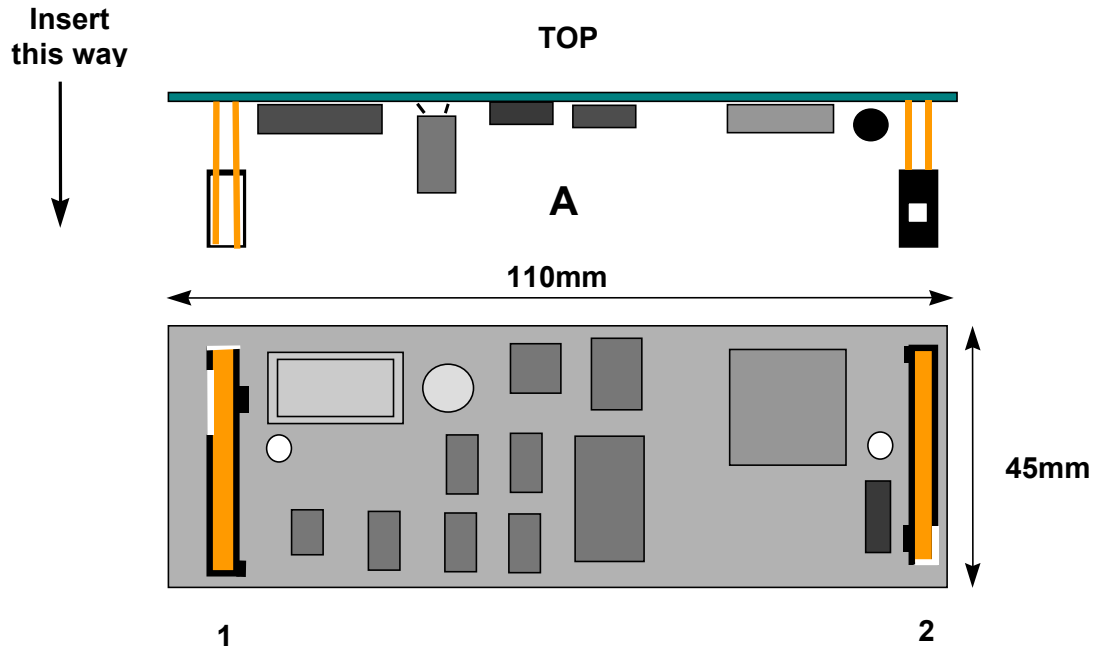

Locate ISDN capability module into slot 17 on the main board observing the insertion keys on the main board connectors

ISDN clocking card (upgrade module) location

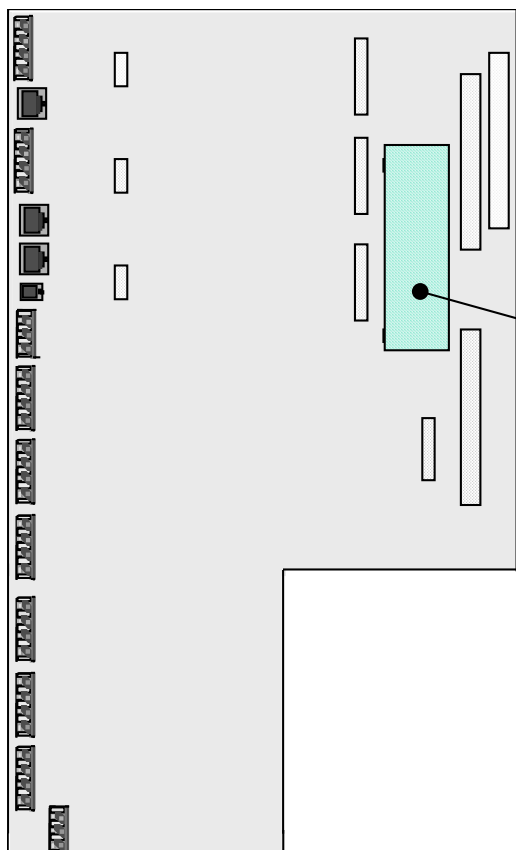

ISDN upgrade module. Must be fitted when using ISDN. The module connects to the main board in one direction only. This is determined by keys on the edge connectors.

ISDN2 card (BRI)

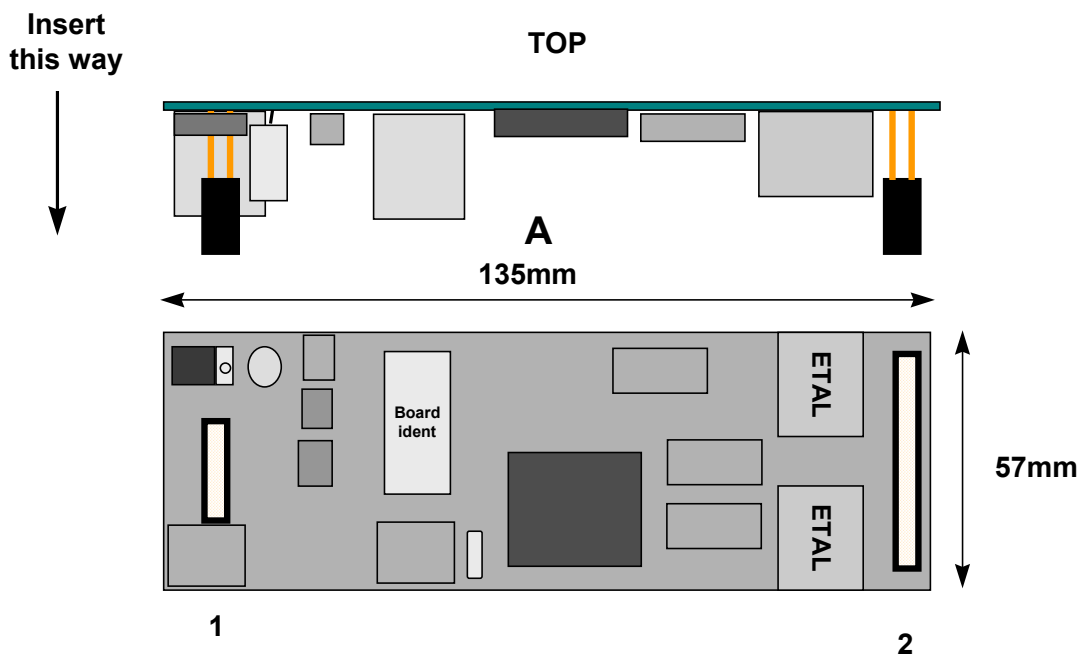

Locate ISDN expansion card into connector 14,15 or 16 or on connector 9 on extension expansion card

Allowed locations of ISDN expansion card

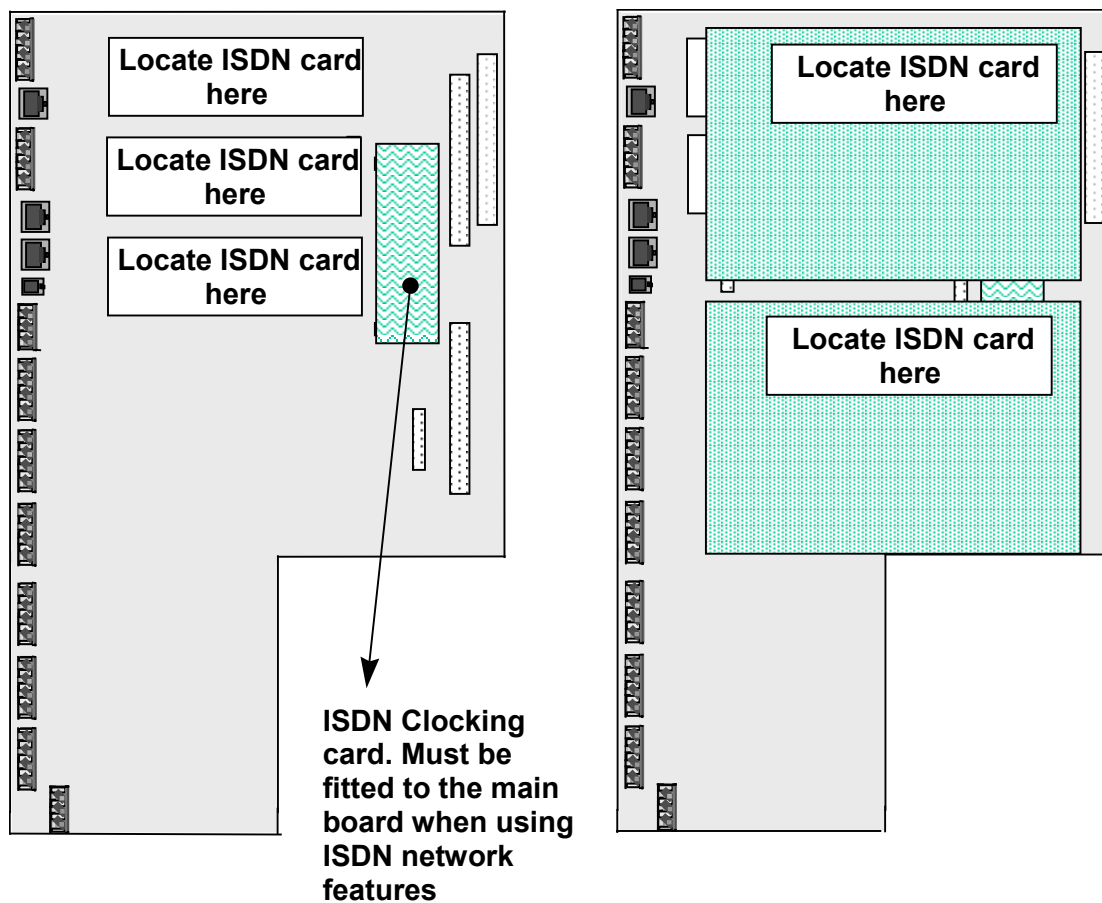

System ISDN settings

The system can be configured with five ISDN interfaces. Two of these can be configured for internal So operation. The So interfaces provide ISDN to-the -desk, allowing users send voice and data information over the ISDN network.

Terminating resistors

The ISDN interfaces on the base motherboard are fixed. Connectors 10 and 12 are for network interfaces (T_o) and location 9 is for an internal S-Bus (So Interface). Each of the T and S interface connectors has two jumpers JP-A, JP-B and JP-C (see diagram below).

These are used to insert or remove a 100-ohm termination resistor from each of the interfaces. Inserting the jumpers terminates the line with 100 Ohms. The unit is delivered with the jumpers connected across the two pins (the 100-ohm termination provided)

In normal operation the NTE provides termination on one end of the S-Bus. Consequently the So interface must always have the terminating resistor JP-C connected (the So interface emulates the NTE).

In situations where the BT Pathway is not required to provide the S-Bus 100 ohm termination on the T_o interfaces, the jumpers JP-A and JP-B may be removed. It is recommended the link be inserted on one of the pins to ensure it is not lost.

Base motherboard connections

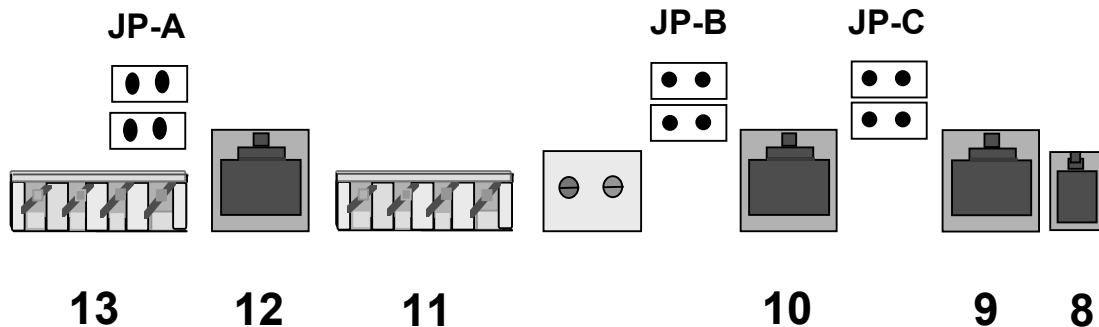

The base motherboard provides the default So slot (slot 16 - See the base mother board description in this manual). As the system can provide two So interfaces, the second So can be provided by an ISDN interface card connected to **either** of the extension expansion boards.

Only one of the extension expansion cards can be set for So operation

Expansion board connections

There are two sets of four jumpers on the extension expansion card, which provide ISDN/S-Bus set-up options when the ISDN expansion card is connected into slot 9.

The four jumpers at the back of the RJ45 connector (J1, J3, J4 and J2) must be moved to the S position for So operation. In default, the jumpers are set in the T position for To operation.

When changing the jumper settings from the default position, the system must also be programmed from T to S operation. See the owner's manual or Camino for programming details.

There are 4 jumpers beside the RJ45 connector. JP-2 and JP-1 are the 100-ohm terminating resistors (connected in default mode).

The expansion board ISDN interface can provide a 40Volt supply to connected ISDN devices. Up to 4 devices (maximum) can be powered by this 40Volt supply, on each S-Bus. The option to provide or remove this voltage supply is available on the extension expansion board by inserting or removing jumpers. Please see the following diagram.

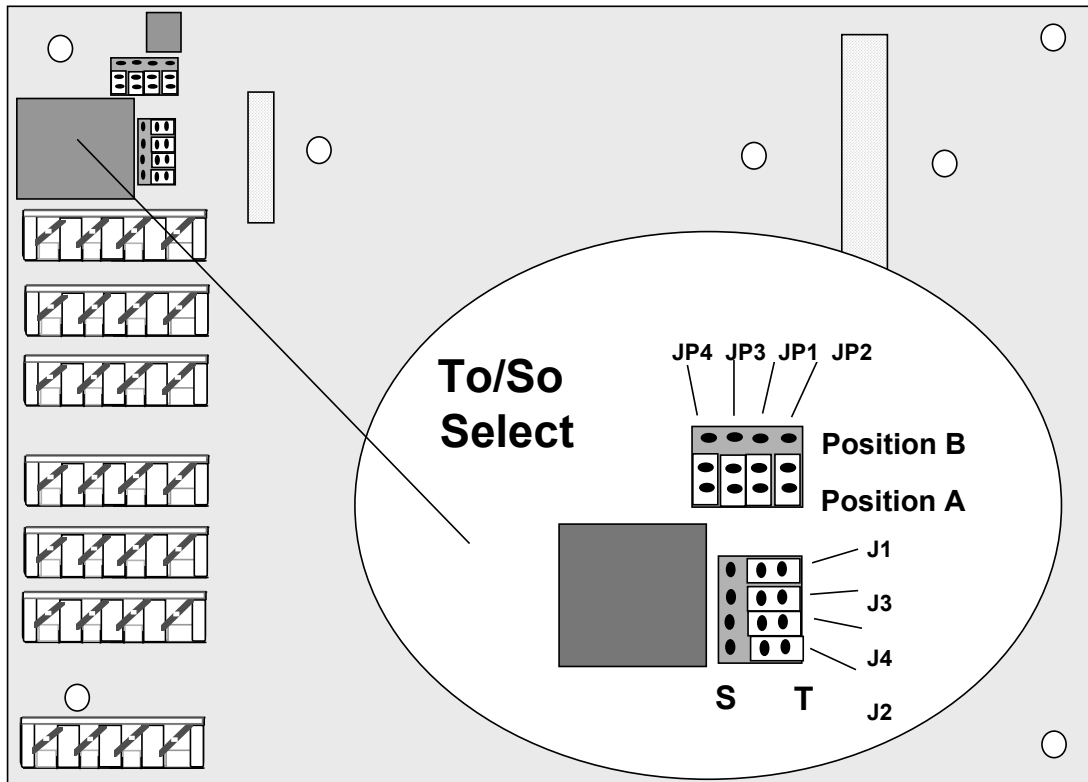

	JP-1 Terminating Resistor	JP-2 Terminating Resistor	JP-3 ISDN So 40V Supply	JP-4 ISDN So 40V Supply
Position A	100 Ohm out	100 Ohm out	No So 40V	No So 40V
Position B	100 Ohm in	100 Ohm in	40V supplied	40V supplied

For J1 to J4 - Move all the Jumpers to the T position for To operation and to the S position for So operation

Voice Mail

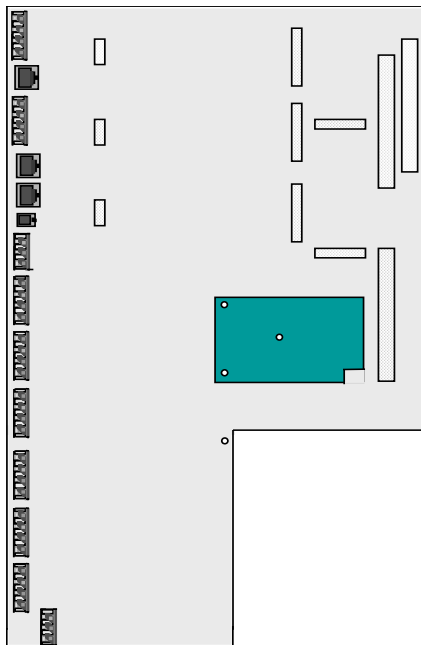
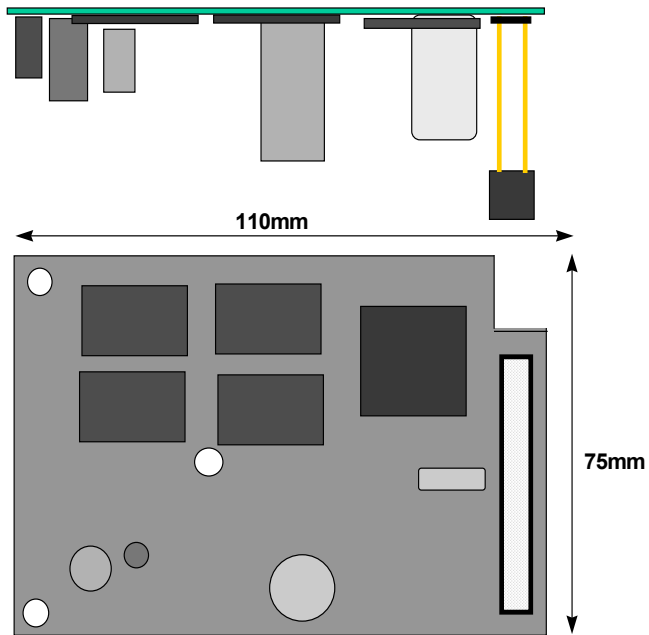

Locate the Voice Mail card in slot 18 on the main board

V24/SMDR Serial port

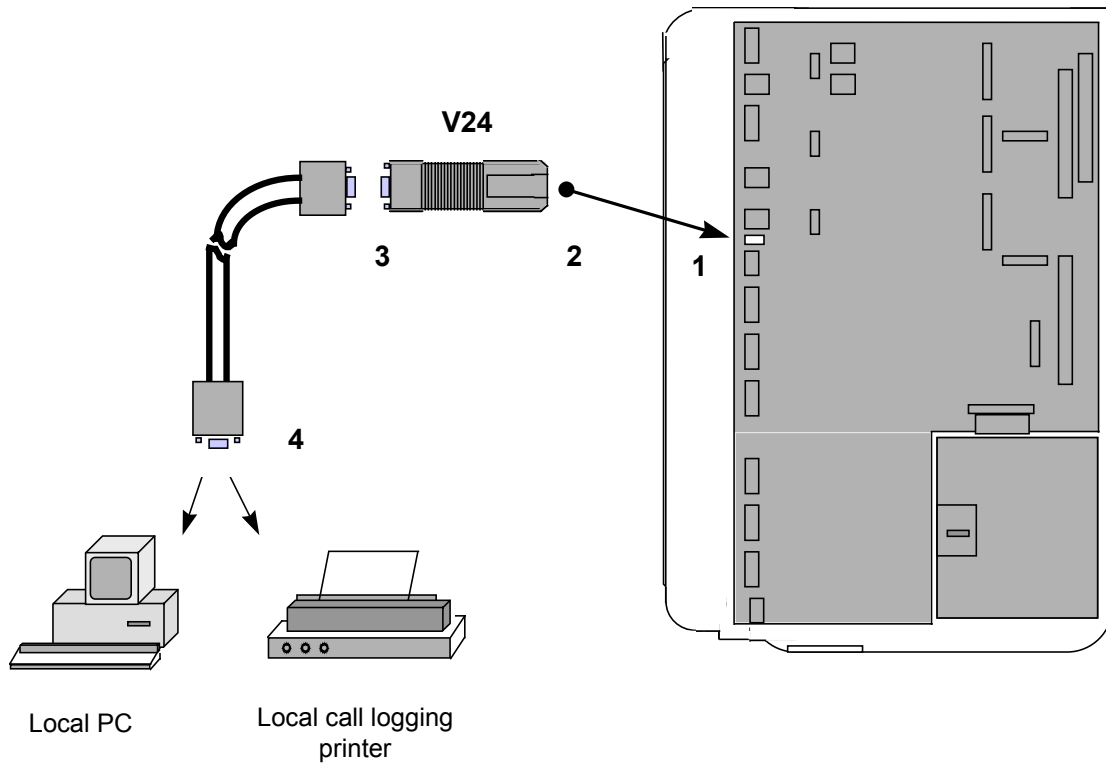

- 1. RJ11 Connector
- 2. RJ11 Socket
- 3. RS-232 9 way male to female connection
- 4. RS-232 9 way male connection

- V24 interface in the base mother board
- External port input from switch
- RS 232 external serial port output from switch
- Serial cable connection to terminal device

Note

The cable connection from the switch to the external serial module is via a cable, 1 meter in length. This cable connects the external serial module to connector 8 on the base motherboard.

External serial port cable and connectors

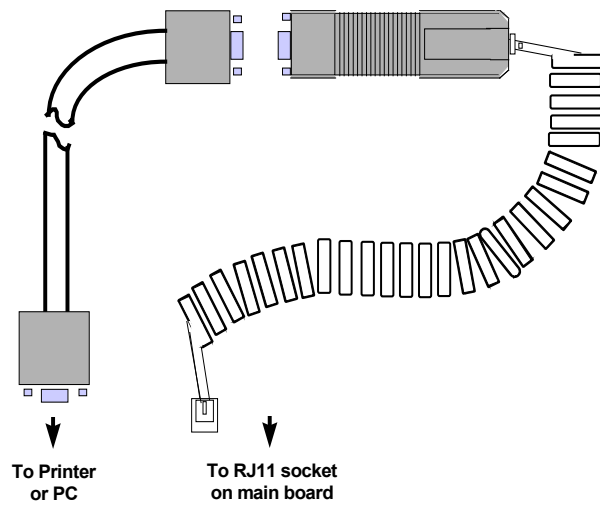

External serial port Pin-out

Female 9-Way connector which plugs in to a local printer or PC

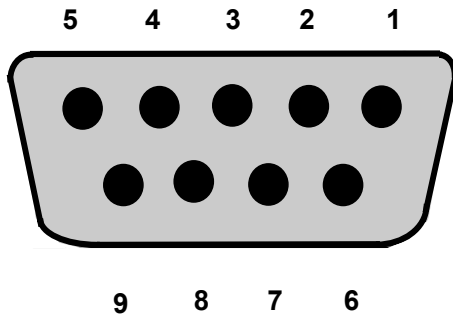

Note 5

A standard, commercially available, DB-9 to DB-25 way converter connector will operate with the external serial port when connecting to equipment which is not fitted with a DB-9 connector as standard.

9 Way D-Type connector Pin Description

Pin 1 - DCD Data Carrier Detect Pin
Pin 2 - Receive Data Pin
Pin 3 - Transmit Data Pin
Pin 4 - DTR Data Terminal Ready
Pin 5 - Signal Ground
Pin 6 - DSR Data Set Ready
Pin 7 - RTS Request to send
Pin 8 - CTS Clear to send
Pin 9 - RI Ring Indicate

Equivalent 25 way D-Type Pin Description

Pin 8
Pin 3
Pin 2
Pin 20
Pin 7
Pin 6
Pin 4
Pin 5
Pin 22

Door Intercom

The door intercom must connect to the extension 23 position on the base motherboard.

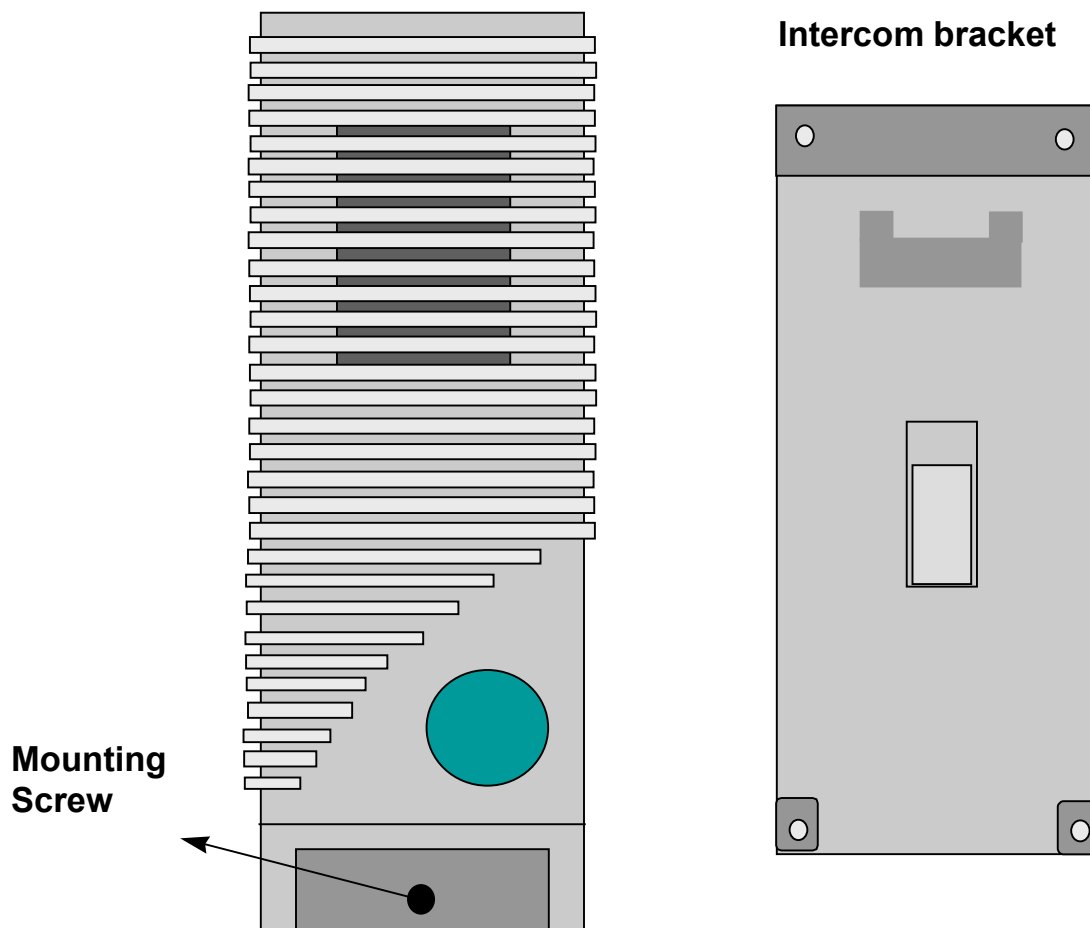

Connect the single pair from the door intercom to the AB connections on extension 23.

The door intercom must be programmed in the System. See the owners manual for the programming details.

Replacement of system Printed Circuit Board (PCB) modules

1. Record the system configuration and administration programming.
2. Disconnect the power.
3. Unplug the Expansion Cards PCB (if fitted).
4. Ensure all extension and ISDN line cabling is tagged to ensure it can be correctly reconnected.
5. Disconnect the extension and ISDN line cables.
6. Remove the PCB.
7. Insert any expansion PCBs on the replacement PCB.
8. Reconnect the extension and ISDN line cabling.
9. Reconnect the power.
10. Reprogram the system as required.

Power supply

The power supply connects to the Base Motherboard via two ribbon cables. The larger ribbon cable supplies power to the main system and the smaller ribbon cable supplies power to the Battery Backup Unit. The power supply can be backed up with a battery unit, which connects to the Base Motherboard.

Main Connector

Pin 1	Ringing switch	Not applicable
Pin 2	-31 Volts Analogue	With respect to Pin 3 output +9Volts +/- 5%
Pin 3	-40 Volts Digital	Reference pin for output voltages
Pin 4	-35 Volts	With respect to pin 3 output +5Volts +/-3%
Pin 5	-45 Volts	With respect to pin 3 output -5Volts +/-3%
Pin 6	0 Volt Protect	Not applicable
Pin 7	Protective Earth	Connected to system protective earth
Pin 8	-40V Analogue	As pin 3
Pin 9	Ringing source	Not Applicable
Pin 10	No Connection	Not Applicable
Pin 11	-40V Volts Protect	With respect to Pin 12 -40 Volts Internal S-Bus supply
Pin 12	0 Volts Protect	Reference pin for internal S-Bus supply

BBU Connector

Pin 1	0 Volts	Reference pin for pin 2
Pin 2	49 Volts	With respect to Pin 1 output 49Volts +/- 2Volts
Pin 3	Not Used	Not applicable
Pin 4	0 Volts	Reference pin for pin 6
Pin 5	Not used	Not applicable
Pin 6	41.5 Volts	With respect to pin 4 output 41.4Volts +/- 1.5Volts

Replacing a power supply unit

Before replacing the power supply, please verify that the mains fuse and the power supply fuse have not blown. See caution below

The mains fuse is a standard 250 Volt 3A device

The power supply fuse is a 20mm 250V 1.6A HT device (anti-surge ceramic body, high rupture capacity)

The battery back up charging circuit in the BBU case has a fuse on the circuit board. This is a 20mm 6.3A HT device. See the next section for information on the battery isolation fuse.

The power supply fuse is located beside the mains lead, screw terminal connectors on the power supply circuit board. This is located under the power supply cover

CAUTION

The power must be disconnected before removing or installing the PSU

CAUTION

The power must be disconnected before removing or installing the PSU
--

1. Disconnect the power.
2. Disconnect the battery if fitted.
3. Remove the power supply cover.
4. Disconnect the mains lead.
5. Disconnect the lead to the main PCB.
6. Unscrew the two retaining screws and lift out the PCB.
7. Re-insert the new power supply.
8. Insert the two retaining screws.
9. Reconnect the lead to the main PCB.
10. Reconnect the mains lead.
11. Replace the power supply cover.
12. Reconnect the power.

Installing the battery back-up

Caution - the diagram below shoes the Battery Back Up with the cover removed.

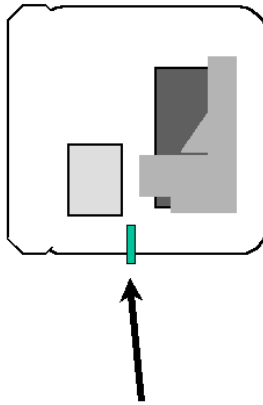

When connecting or replacing the BBU remove the fuse (10 Amp 250V [F]) at the bottom of the unit. Replace ONLY when the BBU cable has been connected or disconnected to/from the Base Motherboard

**When Fitting
battery back up
unit**

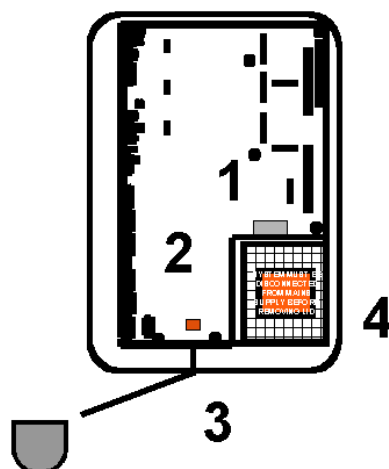

Break-out section

1. Ribbon cable to base mother board
2. Battery backup cable socket
3. Break out section for BBU cable
4. Power supply anti shock cover

- (Power supply to system)
- (Keyed connector for BBU cable -when fitted)
- (Removable plastic moulding)
- (Removable when mains supply is isolated)

Mounting the Battery Backup unit

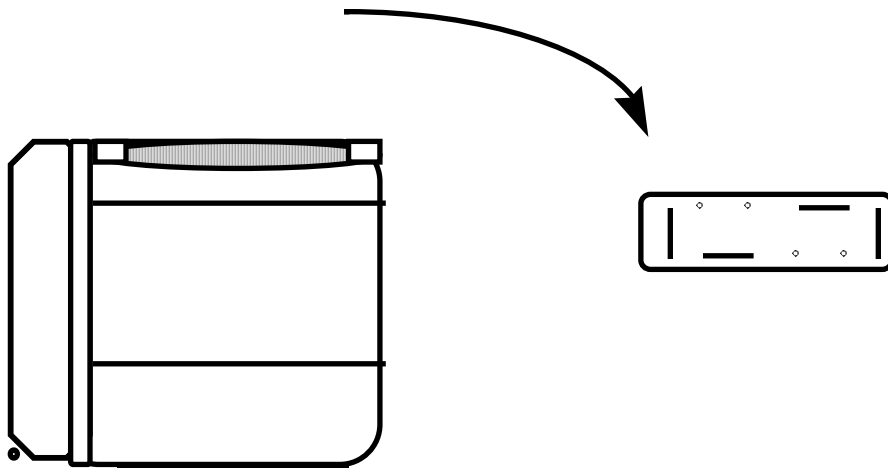

The Battery back up unit is mounted on the same bracket as the main CCU. Please refer to the section of this manual referring to the fixing of the CCU. The Battery Backup unit (BBU) contains a 7.2 Ah rechargeable Battery. This battery sits in a bracket within the BBU case.

Insert the battery, bottom-first into the mounting bracket using clockwise motion

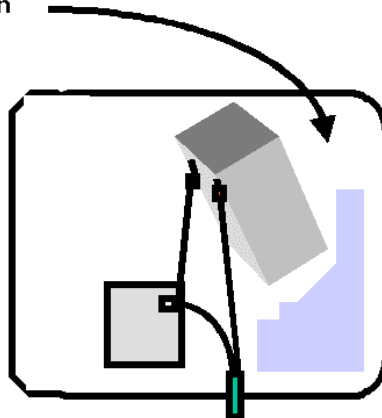

The cable connecting the positive terminal of the battery to the BBU circuit board is attached via the fused, keyed connector. Unplug the connector from the circuit board before inserting or removing the battery and then connect/disconnect the battery terminals. When work on inserting or removing the battery is complete, reconnect the cable to the circuit board

Extension Port (22)

This port is designed to work up to a distance of 2 kilometres away from the main unit and is approved for connection of 2-wire external extensions using PTO network cabling. Extension 22 should be the only extension using this cable

Cable limitations:

- 2-wire external extension = 2 kilometres maximum cabling distance or 3 dB at 1600 Hz.
- The cable route should not be exposed to high voltage surges (e.g. Lightning)

Note - *These figures are assuming a cabling conductor size of 0.5mm copper diameter.*

Central Bell

It should be noted that the BT Pathway is provided with a connector for a Central Bell. This is a single pair on which ringing is supplied. The Central bell can be provided by running a cable pair from the Central Bell IDC see position 7 on the base motherboard to a master line jack unit. Bells/tone callers can then be connected to the line jack unit or hard-wired to LJU terminals 3 and 5.

Doorstrike

The Doorstrike port provides a closed relay contact when in the operated condition. The relay contact is designed for low voltage DC equipment and should not be used for any voltages greater than those specified within the technical specification.

Note:

All internal extensions terminated within the customer's premises should connect into standard line jack units. When extension 22 is using the long line facility (Max. 2 Km from the CCU) an earthed line surge protector should be fitted to the line.

General cabling and wiring information

Do not exceed the following resistance limit when connecting extensions to the CCU (0.5 mm tinned copper conductor).

100 ohms or 300 metres for Systemphone extensions

100 ohms or 500 metres for standard 2-wire telephone extensions

336 ohms or 2 kilometres for 2-wire extension connected to extension position 22.

Great care should be taken when selecting the cable routes to ensure that the cabling complies with current cabling requirements.

The extension and ISDN line cables must be of twisted-pair construction using insulated tinned copper wires of nominal 0.5mm cross-sectional area. It is important that this size and type of wire is used as incorrect types could result in unreliable connections.

The extension and ISDN line cables enter the CCU at the bottom left-hand side of the CCU when viewed from the front of the case. Pass the cables through the cable entry hole in the CCU case. The cables should then be passed through the cable retaining straps until adjacent to the relevant connectors.

There are punch-outs for the ISDN and V24 connectors.

The cables should remain sheathed inside the CCU housing within reach of the connector. Guide the cables neatly into the channel space between the connector and the CCU case side, ensuring that there is sufficient clearance between the cables and the CCU case lid.

MDF Wiring technique

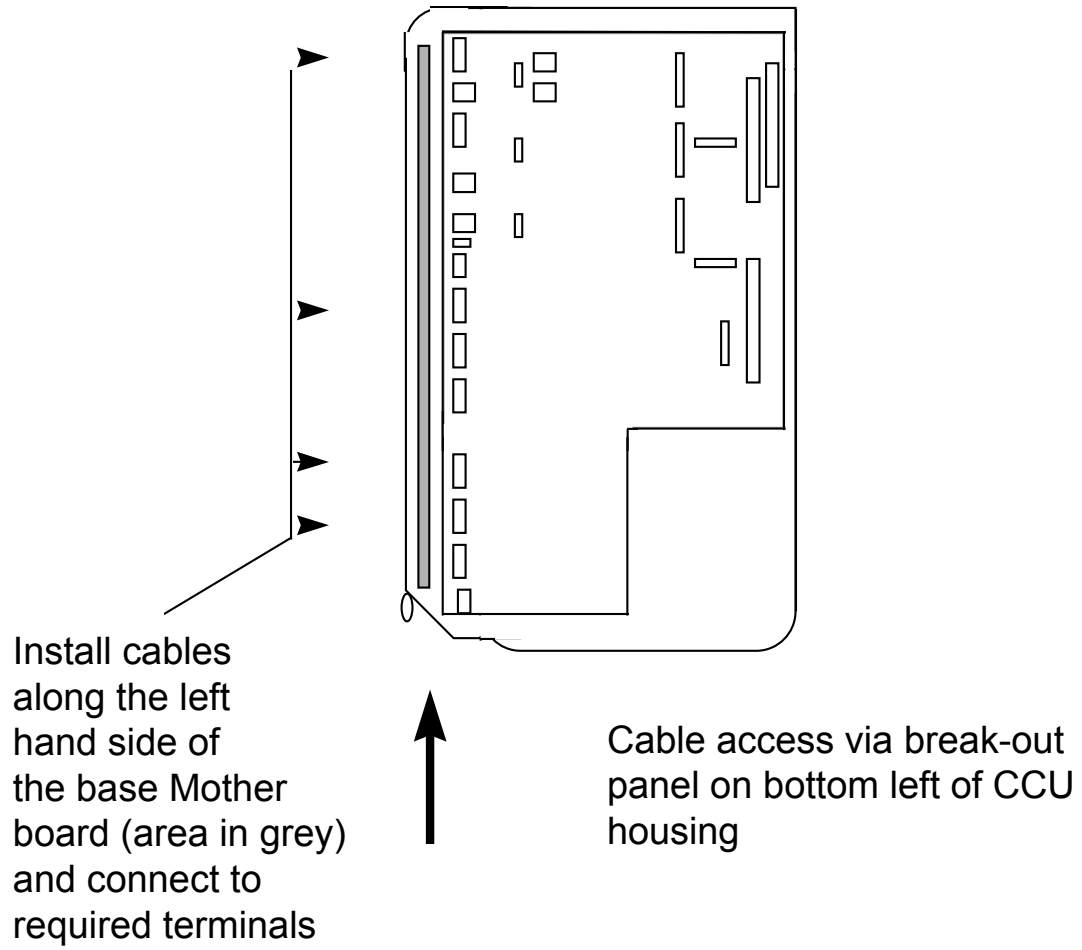

Connecting the extensions

Note - Only four wires per extension are connected at the CCU; spare wires must be neatly laid back away from the connectors. To prevent cross talk or interference, cable pairs should not be split or the spare wire of cable pairs used.

Protection of the CCU and telephones against high voltage surges is recommended where extensions and external cabling are likely to be subjected to induced high voltage surges such as lightning.

Analogue Extensions are numbered 20 to 37.

Run cable from the CCU to each extension telephone location. Pass the cable through the cable entry hole in the CCU and terminate the extension wiring in accordance with the table below.

CCU Extension pairs	Function	Master LJU pin-out	RJ11 Pin-out
A	Speech	Pin 2	Con 3
B	Speech	Pin 5	Con 4
C	Data	Pin 1	Con 2
D	Data	Pin 6	Con 5

Standard 4-Wire IDC Krone connector

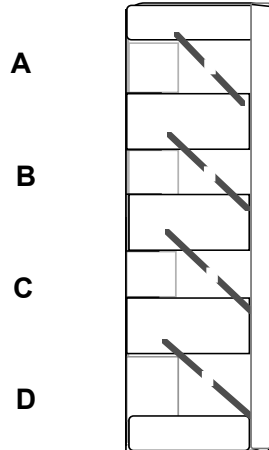

Systemphone

Note: On the diagram below, the HANDSFREE key is shown. On the Monitor Systemphone this show the word "MONITOR".

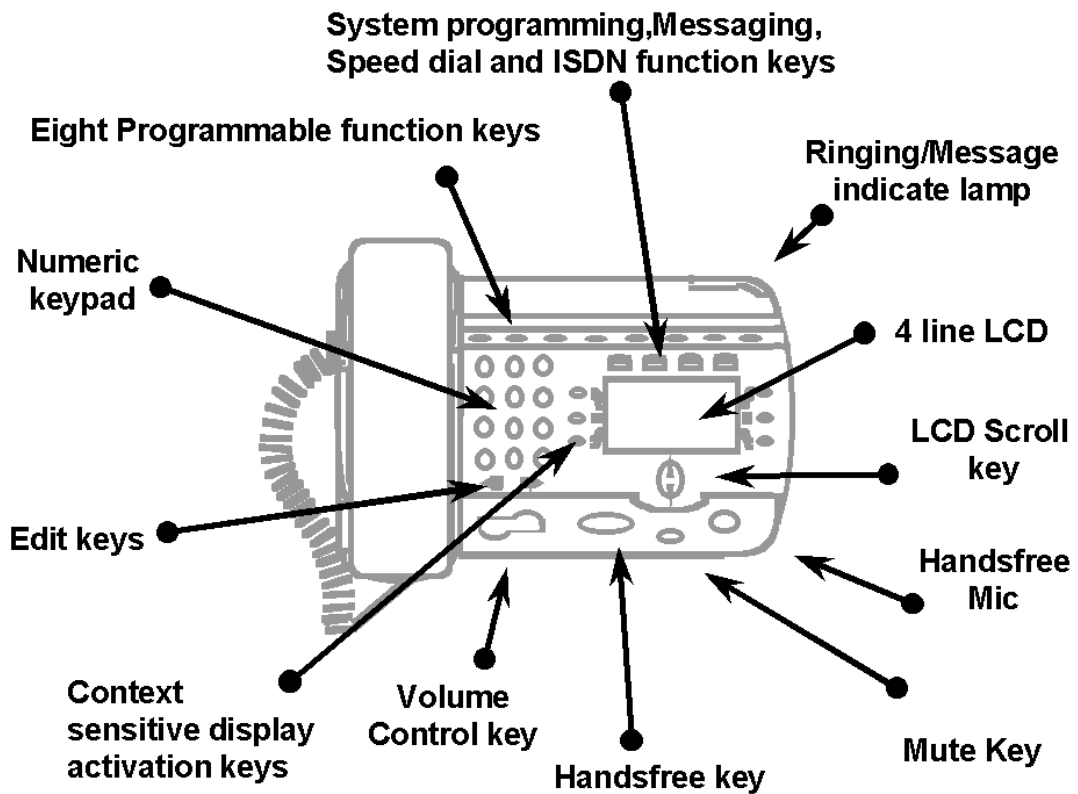

Feature Phone connections

The under-side of the system phones has an RJ11 (4-way) connector for the handset and an RJ12 (6-way) connector for the line cord.

Placing the Systemphone on a desk top

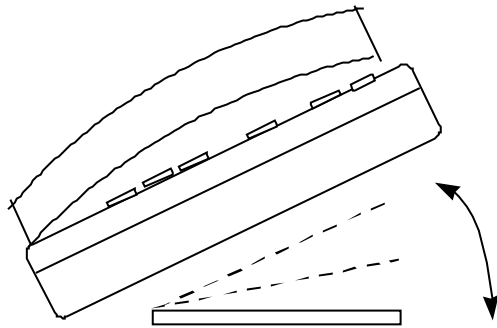

The SystemPhone may be attached to the desk top plinth at two angles. One angle elevates the display to a higher level.

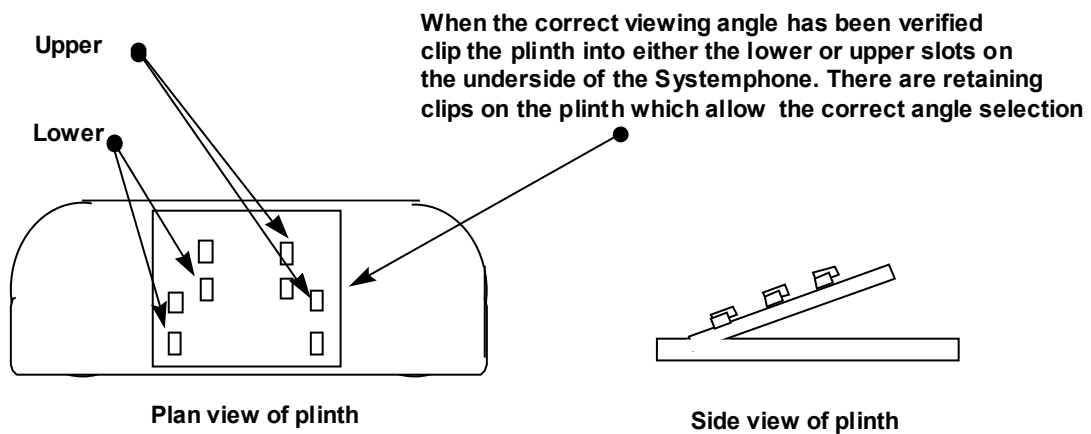

Wall mounting a Systemphone

Locate, drill and plug the two screw locations as shown. The holes should be deep enough to accept a 2.5cm screw. Screw in the two screws, leaving 3 or 4mm protruding. Remove the plinth from the base of the phone and locate the two keyhole slots on the base of the phone over the two screws. Push the Systemphone down onto the protruding screw-heads the plinth is not used.

Locate the two mounting screws 158mm apart



The handset-retaining clip, located directly below the hook-switch, must be reversed so that the handset is secure when the phone is wall mounted.

Power fail

PSTN

In the event of a total system power failure at least 50% of the equipped lines are switched to extensions. Lines 1 and 2 are power failed to extensions 24 and 25 the last two extensions on the basic unit. Line 5 is power failed to extension 31 and Line 7 to extension 37, the last extensions on each of the expansion boards.

NOTE:

If lines are power failed to extension positions equipped with Systemphones the user must replace the Systemphone with a standard two-wire phone to answer or make calls.
SYSTEMPHONES DO NOT OPERATE DURING POWER FAIL.

Line Position	Power fail extension
Line 1	Extn.24
Line 2	Extn 25
Line 5	Extn.31
Line 7	Extn 37

Each board with PSTN exchange line capability is equipped with a power fail circuit path

ISDN

In the event of a total system failure, the ISDN lines will NOT operate. ISDN devices can be connected directly to the ISDN NTE or So bus and work independently of the system.

Connecting to the network

Analogue/PSTN lines

The same IDC Krone connector type is used when terminating analogue lines as is used for terminating the extensions. In this case the first A-B pair is used to terminate one line and the second C-D pair is used to terminate the second line.

206 Line termination

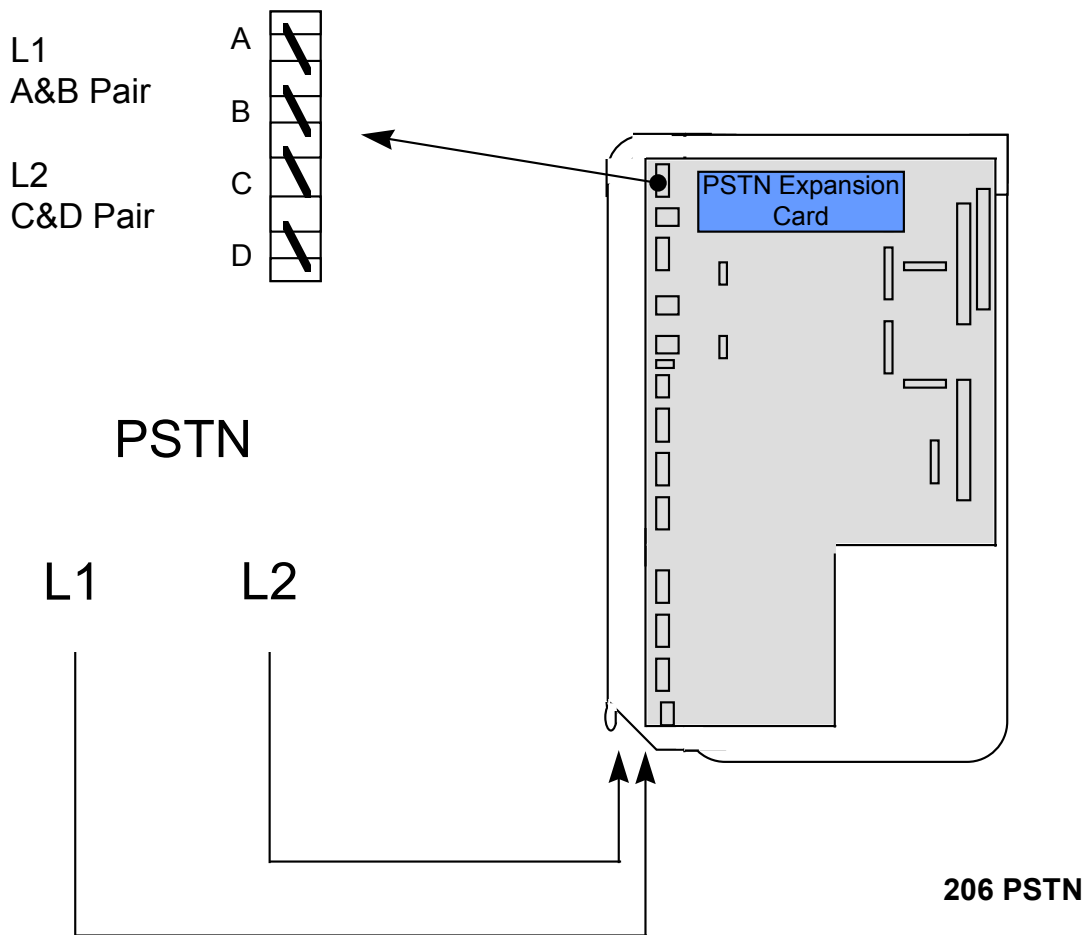

412 Line termination

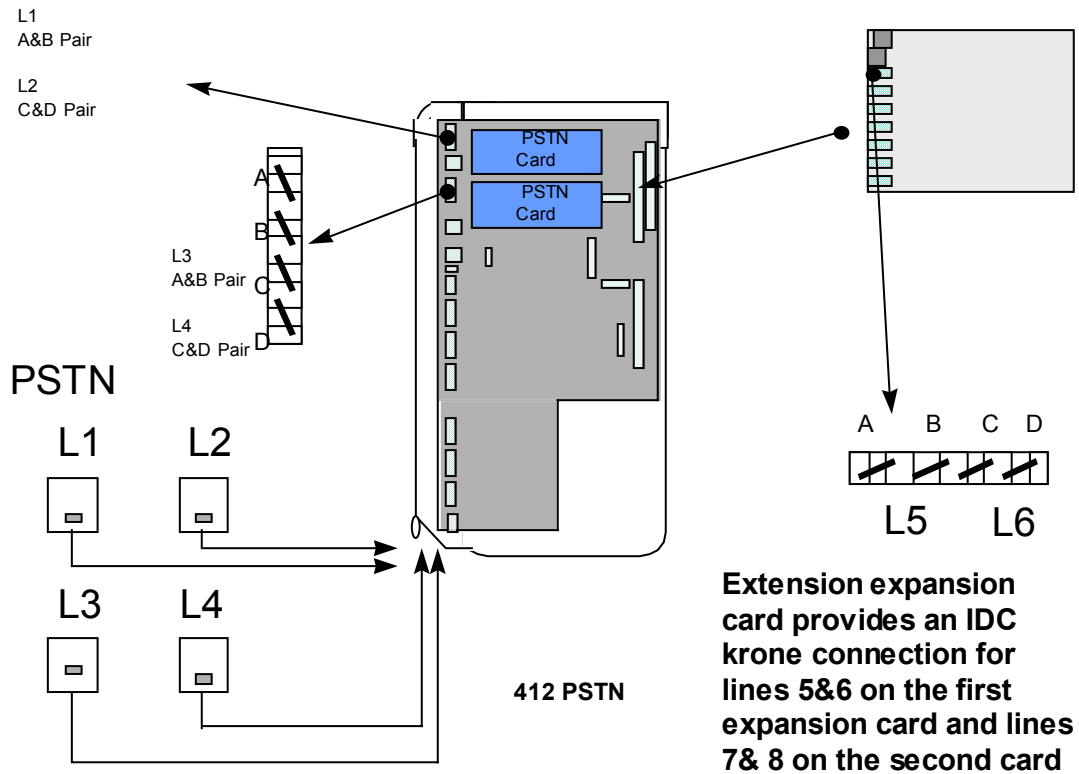

Note:

The system may be configured with eight analogue/PSTN lines. Where the line provision is not supplied on the base motherboard, the incoming line termination is made on the extension expansion card. This IDC/Krone connector is located at position 7.

ISDN Lines

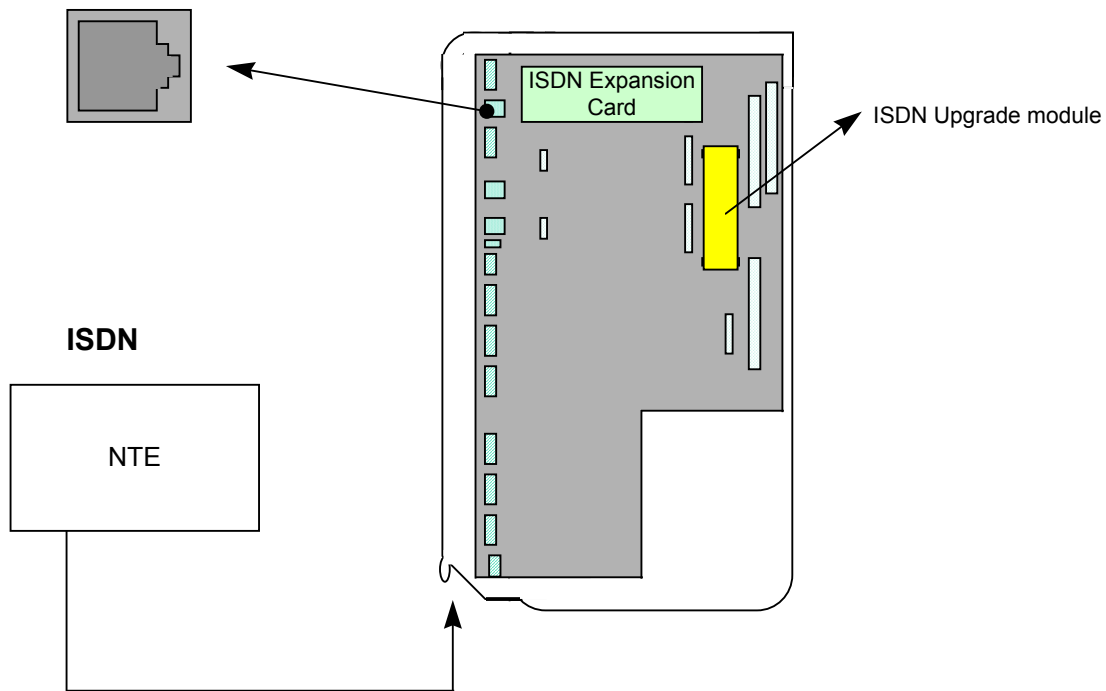

1 To6 ISDN

Connect an ISDN cable from the Network terminator to the RJ45 socket on the base mother board

S-Bus terminating socket

1 To& Optional So fitted

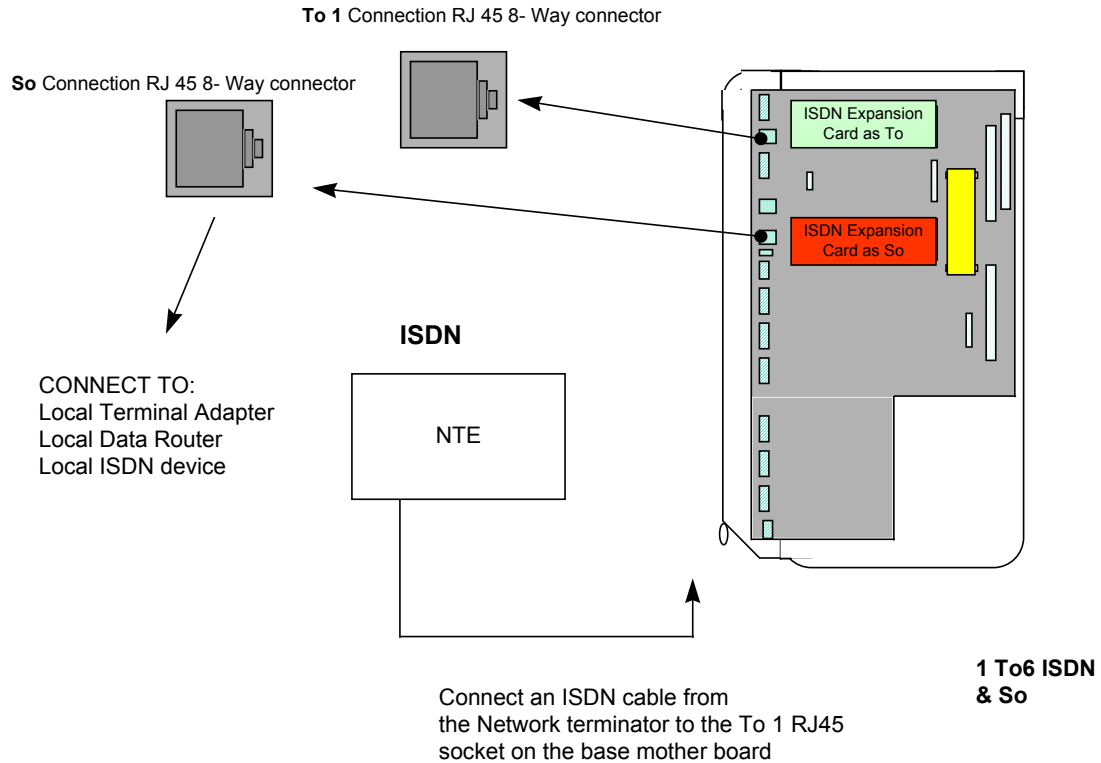

Installation completion & power up

When the installation is complete please carry out the following procedures

Wiring and module insertions

- Ensure using suitable ESP, that all system module PCB's are secured correctly and that all column supports are fitted to their relevant positions
- Visually verify all Krone IDC punch down terminations on positions fitted with Systemphones and standard 2-wire POTS phones
- Ensure there are no screws or metal objects loose within the CCU housing as this may cause damage on power up
- Refit the CCU cover

Refitting the CCU Cover

Break out sections on CCU cover allow space for expansion cards fitted to the base mother board.

When upgrading or refitting modules onto the base mother board ensure the relevant break out panel has been removed prior to refitting the CCU cover

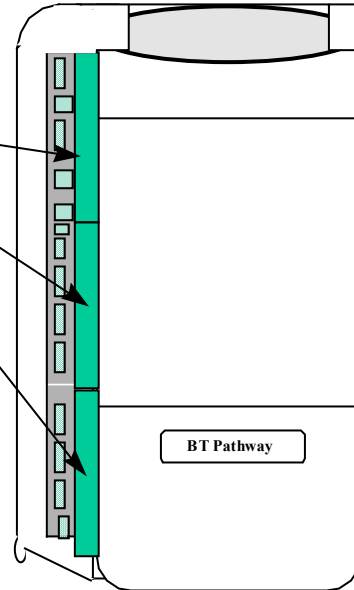

Power up and test

- Ensure the mains plug is fitted with a 3A cartridge fuse
- Ensure there is a reliable mains earth in the supply socket outlet. This can be done using a 13A socket earth loop impedance tester

Switch on

- Power up the system by inserting the mains plug
- Wait 8-10 seconds for the system power up routine to be complete. During this period you will hear several clicks from the working system as relays are energised
- The Systemphones display the product name and software revision for about 1.5 seconds

Commissioning

1. Remove any anti-scratch protective film from Systemphone LCD
2. Label-up all Systemphones and other telephones.
3. Ensure that all Systemphones provide dialling tone, ringing and Handsfree/Monitor (loud speaking) facilities. Check that the display is not showing corrupt information.
4. Check that all other telephones are connected for dialling and ringing.
5. Make essential changes from the default, for example:

PSTN System

Equipped Exchange lines
Disconnect unused extensions

ISDN System

Equipped Exchange lines
Disconnect unused extensions

Enable features on the system for specific configurations

PSTN System

Enable DISA
Fax Detect
voicemail (Answer machine on I/C lines)
Program door intercom
Program PA position
Forward Recall - If system is piggy-backed
MF/LD signalling

ISDN System

P to P or P to MP
Set BASE MSN & DDI index numbers
CLI Routing
voicemail (Answer machine on ISDN lines)
Program door intercom
Program PA position
PBX access - If system is piggy-backed

Note

As the BT Pathway can support both ISDN and PSTN, it may be necessary to enable features for ISDN and PSTN options on the same system.

Recommendations for Customer Training

When installing a BT Pathway at a customer site, you should:

Ensure that the customer has the Owner's Manual and phone User Guides.

Show the customer how to do the following on their Systemphone:

- Use the function keys
- Use the menus and associated keys
- Program a key
- Change the date and time
- Put names onto the extensions
- Use the Handsfree/Monitor key (explain how it works)
- Transfer a call from an Systemphone to a standard phone (if fitted) and back
- Use the Voice Module feature (if equipped)
- Ensure the customer knows the basics of call handling on the switch

Troubleshooting

All faults can normally be traced quite readily to a particular PCB. Some fault conditions should be checked to see if miss-programming the system has caused them to arise.

- **No incoming calls**
Check that all phones programmed to ring are not programmed for DND (Do Not Disturb)
- **Extension outgoing locked**
If you cannot get outgoing access on a 2-wire telephone, move a Systemphone to the extension. If it shows EXTN LOCK the extension has been locked and you will need the padlock code to unlock it.
- **No extension dial tone**
Check that the extension has not been disconnected through programming
- **Not seizing a line for outgoing calls**
Check if the line has been programmed for incoming calls only.
Check if the line is equipped in programming.
- **Feature phone shows "Waiting for SYNC"** - Extension not properly terminated at IDC/Krone connector
- **Door intercom not operating**
Check Door intercom link is located correctly.
Check the Door intercom programming.
- **Phone reset**
Remember the simple phone reset code 157, which can be dialled from a phone.
- **System reset**
 - **Warm reset:** To do a warm reset of the BT Pathway, enter the programming mode and choose warm reset
 - **Cold reset:** To do a cold reset of the BT Pathway, enter the programming mode and choose cold reset

Technical Specification

Type of System	Hybrid / PBX
ISDN line	ISDN 2e
ISDN line Capacity	
Terminals	Systemphone or Standard 2-wire Telephone
Internal Speech Paths	3
Extension Capacity	18
Systemphone Capacity	18
Standard 2-wire Apparatus Capacity	18
Extension Loop Resistance	100 Ohms (0.5Km) 2 wire phones and (0.3) 4 wire Systemphones
	336 Ohms (1.5 Km) Extension 22 only
Extension Cabling	Standard 4 Wire Twisted pair 0.5 mm ² cu
Central Control Unit	Height 450 mm Width 304.5 mm Depth 71.6 mm Weight 2.5 Kg
Battery case	Height 250 mm Width 304.5 mm Depth 21.6 mm Weight less than 1Kg
Battery	12 V / 7.2Ah
Mains Supply Voltage	220-240V 50Hz
Maximum Power Consumption	75 Watts
ISDN line Signalling	ISDN 2e
Standard 2-wire Telephone Signalling	MF
Standard 2-wire Telephone Recall Signal	Timed Break
Call Logger Interface	V24 Port 4800 Baud, 8 bit, No Parity, 1 Stop Bit.
Music on Hold	External calls only
Tone on Hold	200 ms on 200ms off 200ms on 3. 4 sec off
Central Bell	Separate Port. Ringing applied
System Speed Dials	Max. 200
Extension Current and Voltage Feed	Voice - 40 volts 25mA Constant Current Data - 40 volts 10 mA Constant Current
Dial Tone Duration	20 sec
Programming	Systemphone (default extension 20)
PC Programming / Remote Access	Remote by B- Channel
Ringing voltage / frequency	70 V RMS 25 Hz
Ringing Cadences	Incoming call -400ms on 200ms off/400ms on 2.0s off Internal call -1s on 2s off Door intercom call - 400ms on 200ms off 200 on/2.2s off Call recalling -1s on 400ms off 400 on 1.2 off
Tone Frequencies	425 Hz \pm 15 Hz unless stated otherwise

Tone Cadences	Dial Tone - Continuous tone of 440Hz \pm 5% and 350Hz \pm 5% combined Special Dial tone - 800ms on 800ms off of 440Hz \pm 5% and 350Hz \pm 5% combined Ringback Tone - 400ms on 200ms off 400ms on 2sec off Busy Tone - 400ms on 400ms off Congestion Tone - 100ms on 100ms off Hold Tone - 200ms on 200ms off 200ms on 3.4 sec off Conference tone - One burst of 400ms. NU tone - Continuous tone Call waiting tone - 100ms on 4.9 s off
Environmental Requirements	Normal working temperature 0°C to 45°C Working humidity (non condensing) 10% to 80% Storage temperature -20°C to +70°C Storage humidity 10% to 90%
Doorstrike Relay Contact	Max Rating 24 Volts DC 2 Amps
Safety and Protection	EN60950 EN41003 and EN300-047
system software EPROM	Flash 4 Mb; access-time < 120 ns
Music on Hold or Courtesy service EPROM	1 or 2 Mb:

Configuration Table

	206 PSTN	1T6	406 PSTN	2T6	412 PSTN	2T12
<i>Equivalent to</i>		206		406		412
Base Motherboard	1	1	1	1	1	1
PSTN card	1	N/A	2	N/A	2	N/A
ISDN 2 as To	N/A	1	N/A	2	N/A	2
ISDN 2 as So	N/A	1 optional	N/A	1 optional	N/A	1 optional
ISDN clocking card	N/A	1	N/A	1	N/A	1
voicemail module	optional	optional	optional	optional	optional	optional
Battery Backup unit	optional	optional	optional	optional	optional	optional
6 port extension card	N/A	N/A	N/A	N/A	1	1
V24/SMDR	1	1	1	1	1	1

	612 PSTN	3T12	618 PSTN	3T18	206& 1To	212&1To
<i>Equivalent to</i>		612		618	406	412
Base Motherboard	1	1	1	1	1	1
PSTN card	3	N/A	3	N/A	1	1
ISDN 2 as To	N/A	3	N/A	3	1	1
ISDN 2 as So	N/A	1 optional	N/A	2 optional	1 optional	1 optional
ISDN clocking card	N/A	1	N/A	1	1	1
voicemail module	optional	optional	optional	optional	optional	optional
Battery Backup unit	optional	optional	optional	optional	optional	optional
6 port extension card	1	1	2	2	N/A	1
V24/SMDR	1	1	1	1	1	1

	206&2To	212&2To	412&1To	412&2To	612&1To	618&1To
<i>Equivalent to</i>	612	612	612	812	812	818
Base Motherboard	1	1	1	1	1	1
PSTN card	1	1	2	2	3	3
ISDN 2 as To	2	2	1	2	1	1
ISDN 2 as So	1 optional	1 optional	1 optional	1 optional	1 optional	1 optional
ISDN clocking card	1	1	1	1	1	1
voicemail module	optional	optional	optional	optional	optional	optional
Battery Backup unit	optional	optional	optional	optional	optional	optional
6 port extension card	1	1	1	2	2	2
V24/SMDR	1	1	1	1	1	1

	418&2To	818 PSTN	2T18	418&1To	4T18
<i>Equivalent to</i>	818	818	418	618	818
Base Motherboard	1	1	1	1	1
PSTN card	2	4	N/A	1	N/A
ISDN 2 as To	2	N/A	2	1	4
ISDN 2 as So	1 optional	N/A	2 optional	2 optional	1 optional
ISDN clocking card	1	N/A	1	1	1
voicemail module	optional	optional	optional	optional	optional
Battery Backup unit	optional	optional	optional	optional	optional
6 port extension card	2	2	2	2	2
V24/SMDR	1	1	1	1	1

Power & Environmental Requirements

Mains voltage supply	240V ± 10%.
Power consumption	75 watts.
Normal working temperature range	0°C to +40°C
Extreme working conditions	-15°C to +55°C
Working humidity (non condensing)	10% to 80%
Storage temperature range	-20°C to +70°C
Storage humidity	10% to 90%
CCU housing clearance	100 mm
Battery Back up clearance	310 mm